

Data Sheet

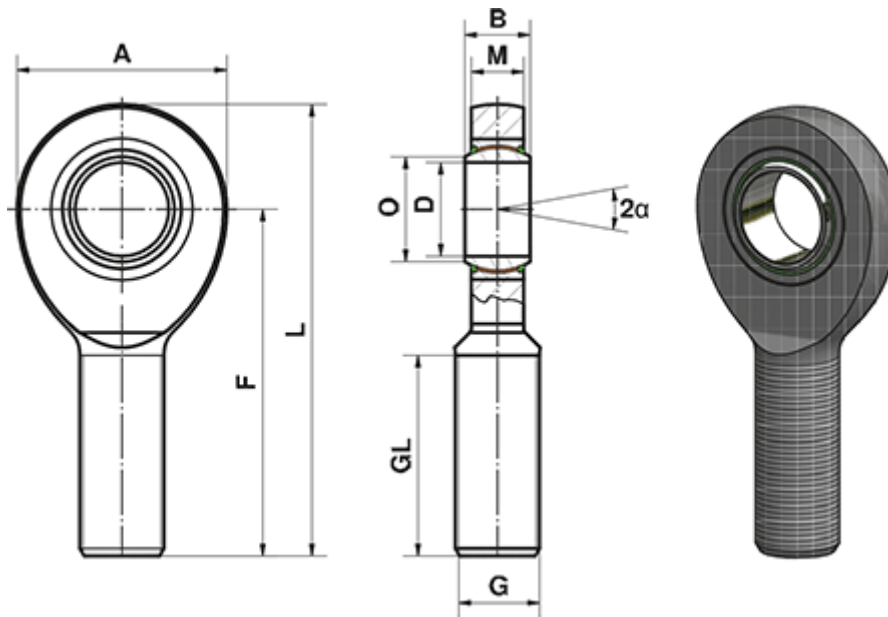

Article number: 03493035
Description: Fluro Heavy Duty Rod end EAL 35 EW-2RS
M36x3 Male thread
Note: 35

Measures



A	= 82	L	= 181
a (degrees)	= 6	M	= 20
B	= 25	O	= 39.7
D	= 35	Static load C0 (kN)	= 144
Dynamic load C (kN)	= 210	Weight (g)	= 1400
F	= 140		
G	= M36x3		
GL	= 82		